







handle with masking plate EMERGENCY-STOP illuminated size 100x 100, for shaft 10x 10, 0-I, handle size 140mm accessory for 3KD size 4 3KF size 4



Model					
product brand name	SETRON				
product designation	handle with masking plate				
design of the product	EMERGENCY OFF				
design of handle	Red-yellow				
design of the door lock system	Door interlocking				
size of cross-section of the shaft of door-coupling rotary operating mechanism	10x10 mm				
size format of the masking frame of door-coupling rotary operating mechanism	100x 100 mm				
length of handle	140 mm				
protection class IP	IP65				
suitability for use	for 3KD size 4, 3KF size 4				
Product details					
product description	with illumination				
product component					
• extension shaft	No				
• handle for emergency-OFF function	Yes				
product feature lockable	Yes				
display version for switch position indicator	0-I				
Mechanical Design					
height	198 mm				
width	195 mm				
depth	105 mm				
net weight	294 g				
Approvals Certificates					
General Product Approval	Marine / Shipping				
					
EG-Konf.		UL	VDE		LRS
other		Environment			

[Confirmation](#)

[Miscellaneous](#)

[Environmental Con-
firmations](#)

Further information

Siemens has decided to exit the Russian market (see here).

<https://press.siemens.com/global/en/pressrelease/siemens-wind-down-russian-business>

Siemens is working on the renewal of the current EAC certificates.

Please contact your local Siemens office on the status of validity of the EAC certification if you intend to import or offer to supply these products to an EAC relevant market (other than the sanctioned EAEU member states Russia or Belarus).

Information on the packaging

<https://support.industry.siemens.com/cs/ww/en/view/109813875>

Information- and Downloadcenter (Catalogs, Brochures,...)

<http://www.siemens.com/lowvoltage/catalogs>

Industry Mall (Online ordering system)

<https://mall.industry.siemens.com/mall/en/en/Catalog/product?mlfb=8UD1851-3CD05>

Service&Support (Manuals, Certificates, Characteristics, FAQs,...)

<https://support.industry.siemens.com/cs/ww/en/ps/8UD1851-3CD05>

Image database (product images, 2D dimension drawings, 3D models, device circuit diagrams, ...)

http://www.automation.siemens.com/bilddb/cax_en.aspx?mlfb=8UD1851-3CD05

CAX-Online-Generator

<http://www.siemens.com/cax>

Tender specifications

<http://www.siemens.com/specifications>

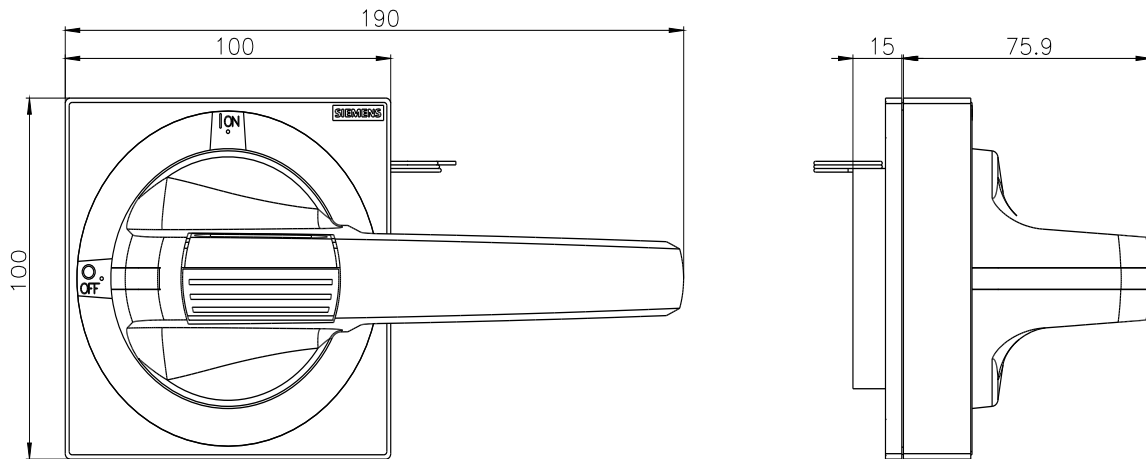

last modified:

7/29/2022

